



TITLE:
**SPECIFICATION FOR 420V
AC AUTOCHANGEOVER
DISTRIBUTION PANEL**

Doc. No.	KP1/6C.1/13/TSP/09/092
Issue No.	1
Revision No.	0
Date of Issue	2015-10-27
Page 1 of 23	

TABLE OF CONTENTS

0.1 Circulation List

0.2 Amendment Record

FOREWORD

1. SCOPE
2. REFERENCES
3. TERMS AND DEFINITIONS
4. REQUIREMENTS
5. TESTS AND INSPECTION
6. MARKING AND PACKING
7. DOCUMENTATION

ANNEX A: *Guaranteed Technical Particulars (to be filled and signed by the Manufacturer and submitted together with relevant copies of the Manufacturer's catalogues, brochures, drawings, technical data, sales records for previous five years, four customer reference letters, details of manufacturing capacity, the manufacturer's experience and copies of complete type test certificates and type test reports for tender evaluation, all in English Language)*

Issued by: Head of Section, Standards Development

Signed:

Date: 2015-10-27

Authorized by: Head of Department, Standards

Signed:

Date: 2015-10-27



TITLE:
**SPECIFICATION FOR 420V
 AC AUTOCHANGEOVER
 DISTRIBUTION PANEL**

Doc. No.	KP1/6C.I/13/TSP/09/092
Issue No.	1
Revision No.	0
Date of Issue	2015-10-27
Page 2 of 23	

0.1 Circulation List

COPY NO.	COPY HOLDER
1	Manager, Standards
Electronic copy (pdf) on Kenya Power server (http://172.16.1.40/dms/browse.php?folderId=23)	

0.2 Amendment Record

Rev No.	Date (YYYY-MM-DD)	Description of Change	Prepared by (Name & Signature)		Approved by (Name & Signature)
0	2015-10-27	New Issue	Michael Apudo Zacheaus Oluoch Jeremiah Kinda Adrian Sagwe	Standards Technical Services, Nairobi	Dr. Eng. Peter Kimemia

Issued by: Head of Section, Standards Development	Authorized by: Head of Department, Standards
Signed:	Signed:
Date: 2015-10-27	Date: 2015-10-27



TITLE:
**SPECIFICATION FOR 420V
AC AUTOCHANGEOVER
DISTRIBUTION PANEL**

Doc. No.	KP1/6C.1/13/TSP/09/092
Issue No.	1
Revision No.	0
Date of Issue	2015-10-27
Page 3 of 23	

FOREWORD

This specification has been prepared by the Standards Department in collaboration with Central Construction Section and Technical Services Section, Nairobi, both of The Kenya Power and Lighting Company Limited (KPLC) and it lays down requirements for 400V AC Auto-Changeover Distribution Panel (ACDP) for use in the substation. It is intended for use by KPLC in purchasing the equipment.

The bid shall be submitted complete with information that confirms satisfactory service experience of the supplier with products which fall within the scope of this specification.

1. SCOPE

- 1.1. This specification intended to cover design, engineering, manufacture, assembly, painting, inspection, testing at manufacturer's works, and delivery to site inclusive of packing & transportation, testing and commissioning assistance of AC Auto-changeover (ACP) and AC Distribution Board (ACDB) complete with all accessories.
- 1.2. The specification also covers inspection and tests of the AC Auto-Changeover Distribution Panel (ACDP) complete with all accessories as well as schedule of Guaranteed Technical Particulars to be filled, signed by the manufacturer and submitted for tender evaluation.
- 1.3. The specification stipulates the minimum requirements for AC Auto-Changeover Distribution Panel (ACDP) with all accessories acceptable for use in the company and it shall be the responsibility of the Suppliers & Manufacturer to ensure adequacy of the design, good workmanship and good engineering practice in the manufacture of the AC Auto-Changeover Distribution Panel (ACDP) complete with all accessories for KPLC.
- 1.4. The specification does not purport to include all the necessary provisions of a contract.

2. REFERENCES

The following standards contain provisions which, through reference in this text constitute provisions of this specification. Unless otherwise stated, the latest editions (including amendments) apply:

IEC 61439-1, 2 & 3: Low Voltage switchgear and Control gear assemblies. --Part 1: General rules; --Part 3: Distribution boards

IEC 61557-1&10: Electrical safety in low voltage distribution systems up to 1 000 V a.c. and 1 500 V d.c - Equipment for testing, measuring or monitoring of protective measures -- Part 1: General requirements; -- Part 10:

Issued by: Head of Section, Standards Development	Authorized by: Head of Department, Standards
Signed: 	Signed: 
Date: 2015-10-27	Date: 2015-10-27



TITLE:
**SPECIFICATION FOR 420V
 AC AUTOCHANGEOVER
 DISTRIBUTION PANEL**

Doc. No.	KPI/6C.1/13/TSP/09/092
Issue No.	1
Revision No.	0
Date of Issue	2015-10-27
Page 4 of 23	

Combined measuring equipment for testing, measuring or monitoring of protective measures.

IEC 60947-1,2, 3&6-1: Low-voltage switchgear and controlgear --Part 1:General rules;--Part 2: Circuit Breakers;Part 3: Switches, Disconnectors, Switch-Disconnectors and Fuse Combination Units--Part 6-1: Multiple function equipment – Automatic transfer switching equipment

IEC 61010-1&2-33: Safety requirements for electrical equipment for measurement, control, and laboratory use --Part 1: General requirements; --Part 2-033: Particular requirements for hand-held multimeters and other meters, for domestic and professional use, capable of measuring mains voltage,

IEC TS 60815-1: Selection and dimensioning of high-voltage insulators intended for use in polluted conditions - Part 1: Definitions, information and general principles

3. TERMS AND DEFINITIONS

For the purpose of this specification, the definitions given in the reference standards shall apply.

- Class PC: ATSE (Automatic transfer switching equipment) that is capable of making and withstanding, but is not intended for breaking short-circuit currents.
- O: Represents a breaking operation;
- CO: Represents a making operation followed, after the appropriate opening time, by a breaking operation:
- t: Represents the time interval between two successive short-circuit operations which shall be as short as possible, allowing for the resetting time

4. REQUIREMENTS

4.1. Service Conditions

4.1.1. Physical conditions

The 400VAC Auto change over panel and distribution board complete with all accessories shall be tropicalized, designed and constructed for continuous indoor operation in tropical areas and harsh climatic conditions including areas exposed to:

- a) Altitudes of up to 2200m above sea level,
- b) Humidity of up to 95%,
- c) Average ambient temperature of +30°C with a minimum of -1°C and a maximum of +40°C,

Issued by: Head of Section, Standards Development	Authorized by: Head of Department, Standards
Signed:	Signed:
Date: 2015-10-27	Date: 2015-10-27



TITLE:
**SPECIFICATION FOR 420V
AC AUTOCHANGEOVER
DISTRIBUTION PANEL**

Doc. No.	KP1/6C.1/13/TSP/09/092
Issue No.	1
Revision No.	0
Date of Issue	2015-10-27
Page 5 of 23	

- d) Heavy saline conditions along the coast and
- e) Annual mean isokeraunic level of up to 180 thunderstorm days.
- f) Seismic level (Horizontal acceleration). : 0.3 g (horizontal); 1.5g (vertical)

4.2. Design and Construction

4.2.1. General

- 4.2.1.1. The AC auto-changeover distribution panel shall be a modular equipment rated 400V at 50Hz consisting of AC Auto-changeover compartment interfaced to an AC Distribution Board. The panel shall comply with the requirements of IEC 61439-1, 2 & 3 and IEC 61010-1&2-33.
- 4.2.1.2. The AC Auto-changeover compartment shall be designed for use as an automatic supply change over panel, which will automatically changeover the supply from the mains to the alternative supply and back again. A third off side shall be provided to be selected manually in the absence of power from the two normal sources using independent, manually operated switch.
- 4.2.1.3. The AC Auto-change-over panel compartment shall have two (2) three (3) phase incoming circuits complete with controls and auxiliary circuits, each with:
 - a) An Automatic transfer switching equipment (ATSE) units rated 250A 400V at 50Hz designed, manufactured and tested in accordance with IEC 60947-1 and IEC 60947-6-1. The ATSE shall be 4-pole in design as per the circuit diagram in Annex B and Fig. 1 of IEC 60947-6-1. The solid neutral pole on the contactor shall be lined with a copper bar per breaker. The ATSE shall be mechanically and electrically inter-locked so that the preferred alternative supply and the mains supply CANNOT be connected to the load at the same time.
 - b) An independently manual operated switch suitable for making, breaking and isolating, rated 250A, 400 V AC at 50Hz designed, manufactured and tested in accordance with IEC 60947-1 and IEC 60947-3 that provide each automatic transfer switch with two-way bypass-isolation.
- 4.2.1.4. AC Distribution compartment shall be equipped with two (2) number 4-pole Switch Fuse Disconnecter Units manufactured in accordance with IEC 60947-3, OR MCCBs manufactured in accordance with IEC 60947-1 & 2 rated 250A, 400V AC at 50Hz, a suitably rated busbar (load bus) and sixteen (16) number of outgoing feeders controlled by suitably rated MCBs designed, manufactured and tested in accordance with IEC 60898-1. In case of tripping of any outgoing feeder MCBs, visual and audible alarm arrangement.

Issued by: Head of Section, Standards Development	Authorized by: Head of Department, Standards
Signed:	Signed:
Date: 2015-10-27	Date: 2015-10-27



**TITLE:
SPECIFICATION FOR 420V
AC AUTOCHANGEOVER
DISTRIBUTION PANEL**

Doc. No.	KP1/6C.1/13/TSP/09/092
Issue No.	1
Revision No.	0
Date of Issue	2015-10-27
Page 6 of 23	

- 4.2.1.5. The design shall also include two (2) other compartments namely-Instruments compartment and Feeder compartment. These compartments shall have doors as described below.
- a) For Instrument compartment, one (1) door with indicating instruments, indicating lamps, selector switches, and nameplate mounted on it.
 - b) For feeders' compartment, one (1) inner door with one opening for handle to operate switch fuse units/MCCBs and cutouts for outgoing MCBs. One outer door without cutouts with non-breakable transparent sheet shall be provided.
- 4.2.1.6. The AC auto-changeover distribution panel shall be designed to facilitate cable entry from the bottom through entry holes of removable plates provided at the bottom of the cubicle. All the accessories required for termination of cable in the AC auto-changeover distribution panel such as screwed brass cable gland, terminal block etc. shall be provided. Glands shall project above the gland plate. The bottom plate shall have the following holes, perforated and easily punched out:
- a) 8nos. 25mm² holes on the distribution side.
 - b) 8nos. 20mm² holes on the distribution side.
 - c) 3nos. 32mm² holes on the side with input Automatic transfer switching equipment (ATSE) units.
- 4.2.1.7. Terminating cables shall be armored and armored rods shall be connected to the earth bus. After isolation of power and control circuit connections it shall be possible to safely carryout maintenance in a compartment with the bus bar and adjacent circuit live. Necessary shrouding arrangement shall be provided for this purpose over the cable terminations located in cable alley.
- 4.2.1.8. The connections from bus bars from the Auto-Change-Over Unit to the main Switch Fuse Disconnecter Unit/MCCBs shall be fully insulated/shrouded and securely bolted. The partition between the feeder compartment and cable alley may be non-metallic and shall allow cable cores with lugs to be easily inserted in the feeder compartment for termination.
- 4.2.1.9. Necessary and safe earthing arrangement with supply of all accessories required for safe earthing shall be within the scope of supply.
- 4.2.1.10. A galvanized steel earthing shall be provided at the bottom of each panel and shall extend throughout the length of the AC auto-changeover distribution panel. It shall be welded/bolted to the frame work of each panel and the breaker earthing contact bar vertical bus shall be provided in each vertical section which shall in turn be bolted/welded to main horizontal ground bus.

Issued by: Head of Section, Standards Development

Authorized by: Head of Department, Standards

Signed:

Signed:

Date: 2015-10-27

Date: 2015-10-27



TITLE:
**SPECIFICATION FOR 420V
AC AUTOCHANGEOVER
DISTRIBUTION PANEL**

Doc. No.	KP1/6C.1/13/TSP/09/092
Issue No.	1
Revision No.	0
Date of Issue	2015-10-27
Page 7 of 23	

- 4.2.1.11. The earth bus shall have sufficient cross-section to carry momentary short circuit and short line fault currents to earth bus without exceeding the allowable temperature rise.
- 4.2.1.12. The horizontal earth bus shall be projected out of the AC auto-changeover distribution panel ends and shall have predrilled holes for bolted connection between this bus to sub-station earthing conductor. A joint spaced and taps to earth bus shall be made through at least two bolts. All non-current metal works of the AC auto-changeover distribution panel shall be effectively connected to the earth.
- 4.2.1.13. The AC auto-changeover distribution panel shall be dust and vermin proof and suitable for use in tropical climate. All ventilating louvers and holes shall be covered with fine non-ferrous wire mesh from inside. The panels shall have at least IP55 protection against enclosure as per IEC 60529:2013 and at least IK08 impact protection as per IEC 62262:2002.
- 4.2.1.14. Suitable rust resisting primer paint (Powder coated Pebble Grey RAL -7032 in colour) shall be applied on the panel after the same is polished and the primer shall be evenly sprayed. The colour of the exterior of the panel shall be of same colour as that of the main control and relay panel. The colour of the interior panel shall be as to provide a colour contrasting background for the wiring inside the cubicle.
- 4.2.1.15. The AC auto-changeover distribution panel shall be mounted on galvanized stands of about 200mm for free standing with removable gland plates for cable entry and shall be complete with channel bottom plates, grouting bolts, earthing bolts, washers, cable glands etc.
- 4.2.1.16. The temperature rise of horizontal and vertical bus-bars when carrying rated current along its full run shall not exceed 40°C with Silver plated joints and 40°C with all other type of joints over an outside ambient temperature of +30°C in accordance with IEC 61439-1.
- 4.2.1.17. All identical circuit breakers and module chassis of same test sizes shall be fully interchangeable without doing any modification work. MCCBs and MCBs shall comply fully with IEC 60947-1 & 2 and IEC 60898-1 & 2 respectively.

Issued by: Head of Section, Standards Development

Authorized by: Head of Department, Standards

Signed:

Signed:

Date: 2015-10-27

Date: 2015-10-27



TITLE:
**SPECIFICATION FOR 420V
 AC AUTOCHANGEOVER
 DISTRIBUTION PANEL**



Doc. No.	KP1/6C.I/13/TSP/09/092
Issue No.	1
Revision No.	0
Date of Issue	2015-10-27
Page 8 of 23	

Table 1: Requirements for 400V AC Auto-change-over Distribution Panel

Sr. No	Description	Technical Particulars	
400V ACDP – In accordance with IEC 61439-1,2 & 3			
1	Dimensions	Height of complete panel (mm.)	1800 (max.)
		Working height (mm.), min	450(min.) to 1650(max.)
		Length (mm.),min	As per requirement.
		Width(mm), min	750 mm (max.)
2	Sheet steel thickness of panel (mm.), min	3	
3	Panel board finish paint	Powder coated Pebble Grey RAL -7032	
4	Ingress Protection	IP55	
5	Clearances	5.5 mm for Upk 6.0 kV as per IEC 61010-1	
6	Creepage distances	25.4 mm for Urms 1800 V, Pollution level III	
7	Insulation resistance of the equipment	>10MΩ	
8	Resistance to corrosion	Severity test A for interior siting	
9	Effective continuity between exposed conductive parts of the assembly and the protective circuits	< 0.1 Ohm	
10	Grade of insulation Level of equipment and wiring (KV)	1.1	
11	Power frequency withstand voltage, Vrms	3.5 kVrms	
12	Lightning impulse voltage, Vpeak	6.0 kVpk	
13	Annunciation for blowing of fuse or tripping of breaker	Alarm and visual indication	
14	Ammeter range	0 to 300 Amps	
15	Voltmeter range	0 to 600 Volts	
16	Accuracy class of Ammeter & Voltmeter	1% of full scale deflection	
17	Current density of Copper for Bus bar (A/sq.mm.)	0.75	
18	Wiring for annunciation scheme shall be done with copper of cross-section area (mm ²)	1.5 (Stranded)	
19	Internal wiring (connection to MCBs) cable size/type & colour	4.0mm ² /10mm ² Insulated copper wire – Red ,yellow& Black as applicable	
20	Earth wiring size and colour code	2.5mm ² Insulated copper wire -Yellow/green wire	
21	Lifting lugs	Test run with the maximum mechanical load	

4.2.1.17.1. Relays and releases for the ATSE shall be defined using the following characteristics:

- a) Standard of manufacture, where applicable;
- b) Type of relay or release;
- c) Rated values;
- d) Current setting or current setting range;
- e) Time-current characteristics
- f) Influence of ambient air temperature,

Issued by: Head of Section, Standards Development	Authorized by: Head of Department, Standards
Signed: 	Signed: 
Date: 2015-10-27	Date: 2015-10-27



TITLE:
**SPECIFICATION FOR 420V
AC AUTOCHANGEOVER
DISTRIBUTION PANEL**

Doc. No.	KP1/6C.1/13/TSP/09/092
Issue No.	1
Revision No.	0
Date of Issue	2015-10-27
Page 9 of 23	

4.2.2. Main Equipment and other Technical Information for A.C. Auto-change Distribution Board

- 4.2.2.1. One set of tinned copper bus bars of adequate continuous rating 250A at 50Hz, short circuit rating of 10kA for 1s; having continuous current density of 0.75 A per mm² shall be provided.
- 4.2.2.2. Auxiliary Relays and contactors for alarm as well as visual indication against tripping of incoming two (2) 250A 4-pole switch fuse disconnecter units/MCCBs as well as outgoing feeder MCBs shall be provided. However, indication will not go off till the restoration of failure. Facility for manual and electrical interlocking of the two (2) input switch fuse disconnecter units/MCCBs and a control voltage for the ACDP shall be 230V AC. Tripping indication shall be provided for the two incoming circuits.
- 4.2.2.3. Two (2) 250A 4-pole manual bypass switches meant to connect main bus to one of the incoming supplies. The bypass-isolation switch shall permit load by-pass to either normal or emergency power source and complete isolation of the automatic transfer switch, independent of transfer switch position. Bypass and isolation shall be possible under all conditions including when the automatic transfer switch is removed from service. The equipment shall operate as follows:
- a) The bypass-isolation switch shall have provisions for operation by one person through the movement of a maximum of two handles at a common dead front panel in no more than 15 seconds.
 - b) It shall provide a lock, which must energize to unlock the bypass switch, to prevent bypassing to a dead source and a means to prevent simultaneous connection between normal and emergency sources.
 - c) Operation of bypass handle shall allow direct connection of the load to the normal (or emergency) source, without load interruption or by using a break-before-make design, or provide separate load interrupter contacts to momentarily interrupt the load to ensure
- 4.2.2.4. Two (2) 250A 4-pole self-acting equipment containing the transfer switching devices (ATSE) and other necessary devices for monitoring supply circuits and for transferring one or more load circuits from one supply to another. These shall be the main sources that are auto-changed in case of failure of any of the source. The equipment shall operate as follows:
- a) The operating sequence of ATSE shall consists of an automatic transfer of a load from the normal supply to an alternative supply in the event of a monitored supply deviation and automatically returning the load to the normal supply when it is restored. The transfer shall be with a pre-set time delay and may include an off position.

Issued by: Head of Section, Standards Development

Authorized by: Head of Department, Standards

Signed:

Signed:

Date: 2015-10-27

Date: 2015-10-27



**TITLE:
SPECIFICATION FOR 420V
AC AUTOCHANGEOVER
DISTRIBUTION PANEL**

Doc. No.	KPI/6C.1/13/TSP/09/092
Issue No.	1
Revision No.	0
Date of Issue	2015-10-27
Page 10 of 23	

- b) In the case of both the normal and the alternative supplies being present, the ATSE shall assume the normal supply position. A variation in the power supply characteristics being monitored shall signal the ATSE to operate when a deviation from the specified limits occurs, for example, abnormal changes in voltage or frequency of the supply.
- c) The ratings and characteristics of control circuit devices and auxiliary circuits shall comply with the requirements of IEC 60947-5 (see note of clause 1).

Table 2: Ratings of the Auto Transfer Switches and the Manual Bypass Switch in accordance with IEC 60947-1, 3 & 6-1

Sr. No.	Property	Units	Requirement	
			Auto-Transfer Switch as per IEC 60947-1 & 6-1	Manual Bypass Switch as per IEC 60947-1 & 3
1	Utilization category		AC-33A	AC-22A
2	Class of equipment		PC	
3	Rated duty			
4	Rated voltage	V		400
5	Maximum power frequency or d.c. recovery voltage.	V		1000
6	Dielectric strength at 50z in 1 min	kV		10
7	Rated impulse withstand voltage	kV		12
8	Rated thermal current	A		250
9	Rated operational power	kW		75
10	Rated operational current, I _e	A		250
11	Rated breaking and making capacity, I	A	1,500	750
12	Rated short time withstand current, I _{cw} for 1s	A		8
13	Rated short time making capacity, I _{cm}	kA		30
14	Rated conditional short-circuit current, I _p	kA		40.5
15	Power loss per pole	W		6.5
16	Operating cycle			O-I-O-II-O
17	Number of operating cycles corresponding to the rated operational current	Cycles		8,000
18	Number of mechanical operations	Oper.		16,000

4.2.2.5. 'ON', 'OFF' and 'TRIP' indicating lamps for both the incoming Switch Fuse Disconnecter Units/MCCBs along with required number of push button shall be provided.

Issued by: Head of Section, Standards Development	Authorized by: Head of Department, Standards
Signed:	Signed:
Date: 2015-10-27	Date: 2015-10-27



TITLE:
**SPECIFICATION FOR 420V
 AC AUTOCHANGEOVER
 DISTRIBUTION PANEL**

Doc. No.	KPI/6C.1/13/TSP/09/092
Issue No.	1
Revision No.	0
Date of Issue	2015-10-27
Page 11 of 23	

- 4.2.2.6. One (1) digital A.C. voltmeter having a scale range of 0-600V.A.C. with approximately 72 x 144 mm² diameter flush mounted, type having accuracy. +/- 1% of full scale, shall be provided. The meters shall have overvoltage category of at least CAT IV 600V as per IEC 61010-1 and shall conform to IEC 61557: Parts 1, 2, 3, 4 & 10 standards.
- 4.2.2.7. Two (2) digital A.C. ammeters with approximately 72 x 144 mm² diameter flush mounted, having range of 0-300 Amps and accuracy +/- 1% of full scale shall be provided for measurement of load current flowing to the A.C. auto-change distribution panel. The meters shall have overvoltage category of at least CAT IV 600V as per IEC 61010-1 and shall conform to IEC 61557: Parts 1, 2, 3, 4 & 10 standards.
- 4.2.2.8. Doors at the back of the panel shall be provided for inspection with door switch for illumination of the lamp to be provided inside the panel with separate switch fuse unit for controlling the lamp.
- 4.2.2.9. All the indicating lamps shall be of panel mounting cluster LED type. The lamps shall have suitable size plates marked with its function, wherever necessary. Lamps shall have translucent lamp covers of 'RED', 'GREEN' & 'WHITE' colour for indicating , 'ON', 'OFF' and 'AUTO-TRIP' indication of incoming switch fuse unit. One (1) indicating lamp is to be provided for tripping of outgoing feeder and AC supervision.
- 4.2.2.10. Space heater shall be provided for preventing harmful moisture condensation in all the compartments. The space heaters shall be suitable for continuous operation of 240V AC, 50HZ single phase supply and shall be automatically controlled by thermostats. Necessary isolating switches and HRC fuses shall be provided.
- 4.2.2.11. All the A.C. MCBS, A.C. Auxiliary Relays, isolating copper links, A.C. emergency MCBS, & A.C. emergency contactors, A.C. bells, indicating lamp for indicating A.C. fail of main bus, A.C. contactors etc. shall be provided. Three (3) Push Button for testing annunciation scheme, resetting annunciation scheme and accept of fault and bell cancellation shall be provided.
- 4.2.2.12. There shall be one (1) terminal board/block for all feeder outlets including cable glands, a facility to select the phase-phase voltage levels and to pick contacts indicating loss of incoming supplies to the remote terminal unit.
- 4.2.2.13. The AC Control and distribution board shall be equipped with double pole MCBs with a Type C tripping characteristic in accordance with IEC 60898-1. The MCBs shall be AC type rated 240V. The outgoing distribution cables shall be connected directly to the relevant MCB. The MCBs shall have the following characteristics;
 - a) Circuit-breakers suitable for A.C circuits with a time constant of T <4 ms.
 - b) Rated short-circuit capacities up to and including 10 kA
 - c) Instantaneous tripping of more than 5In up to and including 10In – C-type curve

Issued by: Head of Section, Standards Development	Authorized by: Head of Department, Standards
Signed:	Signed:
Date: 2015-10-27	Date: 2015-10-27

- d) Rated impulse withstand voltage (U_{peak}) of 4 kV
e) Two-pole circuit-breakers with two protected poles.

Table 3: Technical requirements for MCCB and MCBs as per IEC 60947-2 and IEC 60898-1 & 2 respectively

Sr. No.	Property	Requirement	
		Moulded case	MCB
1	Type of Breaker	Surface-type	Flush-type;
2	Method of mounting	A	
3	Utilization Category	A	
4	Current rating	2 x 250A	1x10A, 8x16A, 4x25A and 4x32A ,2x63A
5	Rated Voltage	240V AC per pole	
6	No. of poles	4	2
7	Type of terminals:	Screw type for external copper conductors	
8	Insulating Voltage	690 V	
9	Rated Impulse Withstand Voltage of main Circuit U _{imp}	8 kV	4 kV
10	Temperature rise	40°C	
11	Instantaneous tripping current	Type C	
12	I ² t characteristic	To be provided by manufacturer	
13	Rated Continuous Current at 40°C	As per Rating	
14	Short-time withstand capacity, I _{cw} for 0.1s	5kA	1.5kA
15	Ultimate Short Circuit Breaking Capacity I _{cu}	30 kA	10 kA
16	Service Short Circuit Breaking Capacity I _{cs}	100% of I _{cu}	
17	Ultimate Short Circuit Making Capacity I _{cu}	63kA	Type C tripping current
18	Maximum power loss	Manufacturer to state	As per Table 15 of IEC 60898-1:2002
19	Suitable for Isolation	Yes	
20	Shunt Release Voltage	230V AC	
21	Permissible Variation in Voltage	85% to 110%	
22	Number of operating cycles	8,000	
23	Termination suitable for Copper	Yes	
24	Insulation Material conforming to Glow Wire Test	Yes	
25	Thermal Over load Settings	Adjustable	
26	Short Circuit Setting	4-pole	Fixed for 2 Pole
27	Degree of protection	IP20	

4.2.3. Factory Wiring

Wiring and labeling either by color-code or by numbered/lettered wire markers shall be done at the factory with proper wire bundling. Labels shall match those on the shop drawings. This shall be as follows:

- a) Current carrying wires shall be black with clearly indicated ferrule labels showing the phase.

Issued by: Head of Section, Standards Development	Authorized by: Head of Department, Standards
Signed: 	Signed: 
Date: 2015-10-27	Date: 2015-10-27



TITLE:
**SPECIFICATION FOR 420V
AC AUTOCHANGEOVER
DISTRIBUTION PANEL**

Doc. No.	KP1/6C.1/13/TSP/09/092
Issue No.	1
Revision No.	0
Date of Issue	2015-10-27
Page 13 of 23	

- b) Earthing wiring shall be done using yellow/green wires.
- c) Control cabling shall be done using grey colour wires with ferrule marking.
- d) Voltage carrying wires shall be colour coded (Red, Yellow, Blue, and Black).

4.3. Quality Management System

- 4.3.1. The supplier shall submit a quality assurance plan (QAP) that will be used to ensure that the 400V ACDP physical properties, tests and documentation, will fulfill the requirements stated in the contract documents, standards, specifications and regulations. The QAP shall be based on and include relevant parts to fulfill the requirements of ISO 9001:2008.
- 4.3.2. The Manufacturer's Declaration of Conformity to applicable standards and copies of quality management certifications including copy of valid and relevant ISO 9001: 2008 certificate shall be submitted with the tender for evaluation.

5.0. TESTS AND INSPECTION

- 5.1. The 400V ACDP shall be inspected and tested in accordance with the requirements of IEC 61010-1, IEC 60947-1, 2, 3 & 6.1, IEC 61439-1&2, IEC 60898-1&2, IEC 60529 standards and requirements of this specification. It shall be the responsibility of the supplier to perform or to have performed the tests specified and whatever other tests he normally performs at works.
- 5.2. Copies of previous Type Tests Reports issued by a third party testing laboratory that is accredited to ISO/IEC 17025 shall be submitted with the tender for the purpose of technical evaluation. The accreditation certificate to ISO/IEC 17025 for the same third party testing laboratory used shall also be submitted with the tender document (all in English Language) Copies of type test reports to be submitted with the tender (by bidder) for evaluation shall be as stated below:

A. Complete assembly as per IEC 61010-1, IEC 61439-1&2

- (i) Electromagnetic compatibility (EMC)
- (ii) Switching tests on the equipment.
- (iii) Impulse overvoltage tests on the equipment -Clearances
- (iv) Dielectric voltage withstand tests on the equipment - Controlled overvoltage
- (v) Functional tests on the equipment.

B. Circuit Breakers as per IEC 60947-1, 2, 3 & 6.1 and IEC 60898-1 & 2

- a) Temperature-rise
- b) Tripping limits and characteristics
- c) Dielectric properties
- d) Operational performance capability
- e) Overload performance (where applicable)

Issued by: Head of Section, Standards Development

Authorized by: Head of Department, Standards

Signed:

Signed:

Date: 2015-10-27

Date: 2015-10-27



TITLE:
**SPECIFICATION FOR 420V
AC AUTOCHANGEOVER
DISTRIBUTION PANEL**

Doc. No.	KPI/6C.I/13/TSP/09/092
Issue No.	1
Revision No.	0
Date of Issue	2015-10-27
Page 14 of 23	

- f) Short-circuit breaking capacities
- g) Short-time withstand current (where applicable)
- h) Performance of integrally fused circuit-breakers

5.3. Routine and sample test reports for the 400V ACDP to be supplied shall be submitted to KPLC for approval before shipment/delivery of the goods. KPLC Engineers will witness tests at the factory before shipment.

5.4. Tests to be witnessed at the factory before shipment shall be in accordance with requirements of this specification and shall include the following:

A. Complete assembly as per IEC 61010-1, IEC 61439-1&2

- a) Degree of protection of enclosures
- b) Clearances and creepage distances
- c) Protection against electric shock and integrity of protective circuits
- d) Incorporation of built-in components
- e) Internal electrical circuits and connections
- f) Terminals for external conductors
- g) Mechanical operation
- h) Electrical tests
 - Wiring, operational performance and function
 - Insulation resistance tests of the equipment
 - Checking of wiring and continuity of the circuit.
 - Power frequency voltage test of 3.5 kV for one minute between wiring and earth terminal.
 - Insulation resistance value of all equipment connected in 400V ACDP and functions of the same.
 - Dielectric voltage withstand tests - Measuring clearances
- i) Functional tests of the equipment
- j) Dimensional and overall checks.

B. Switches and Circuit Breakers as per IEC 60947-2 and IEC 60898-1 & 2

- a) Tripping limits and characteristics
- b) Dielectric properties
- c) Mechanical operation and operational performance capability
- d) Overload performance (where applicable)
- e) Verification of dielectric withstand
- f) Verification of temperature-rise
- g) Verification of overload releases
- h) Verification of under-voltage and shunt releases (if applicable)
- i) Verification of main contact position (for circuit breakers suitable for isolation)

Issued by: Head of Section, Standards Development

Authorized by: Head of Department, Standards

Signed:

Signed:

Date: 2015-10-27

Date: 2015-10-27



TITLE:
**SPECIFICATION FOR 420V
AC AUTOCHANGEOVER
DISTRIBUTION PANEL**

Doc. No.	KP1/6C.1/13/TSP/09/092
Issue No.	1
Revision No.	0
Date of Issue	2015-10-27
Page 15 of 23	

5.5. On receipt of the goods KPLC will perform any of the tests specified in order to verify compliance with this specification. The supplier shall replace without charge to KPLC the 400V ACDP which upon examination, test or use; fail to meet any of the requirements in the specification.

6.0. MARKING AND PACKING

6.1. PACKING

4.3.3. The 420V ACDP shall be carried in a sturdy transport case with hard-foam interior, water tight, air-tight, dust proof, chemical resistant and corrosion proof. The total case dimensions shall not exceed 3800mm x 1200mm x 1200mm in size.

6.1.1. The housing shall be complete with a gasket to seals the lid when closed so as to protect the equipment against water and dirt while the instrument is carried through rainstorms or other hazardous conditions. The lid shall be secured by two latches and a handle for portability. A compartment shall also be provided for storage of test cables and line cord.

6.1.2. The accessories shall be packed in suitable matching bag with a shoulder carrying strap and a hand grip.

6.2. MARKING

The 400V ACDP and its accessories shall be marked in a permanent manner with the following information (in English Language):

- a) Standard to which the 400V ACDP complies
- b) Name of manufacturer
- c) Type of 400V ACDP (description of type, number and overall size of sections)
- d) Year and month of manufacture and serial number
- e) Maximum permissible measurement limits
- f) The words "**Property of Kenya Power & Lighting Co**" shall be engraved permanently on each 400V ACDP while the other parameters shall be marked on a permanent label.
- g) The overvoltage protection category and duty rating e.g. category IV-field
- h) The 400V ACDB shall be provided with a separate permanent label displaying advice to the user.
- i) In addition, the 400V ACDB shall be marked with the necessary labels that conform to IEC 61010-1 clauses 5.1.2 to 5 and its accessories

Issued by: Head of Section, Standards Development

Authorized by: Head of Department, Standards

Signed:

Signed:

Date: 2015-10-27

Date: 2015-10-27



TITLE:
**SPECIFICATION FOR 420V
AC AUTOCHANGEOVER
DISTRIBUTION PANEL**

Doc. No.	KP1/6C.1/13/TSP/09/092
Issue No.	1
Revision No.	0
Date of Issue	2015-10-27
Page 16 of 23	



7.0. DOCUMENTATION, WARRANTY AND TRAINING

7.1. Warranty and Training

- 7.1.1. The 400V ACDB shall be backed by a minimum 12-months factory warranty.
- 7.1.2. If the ACDP new to KPLC, then a two day Training on the equipment shall be carried out by the Supplier's engineer on a KPLC site. The supplier shall meet the cost of this training.
- 7.1.3. After tender award, factory inspection and certification by two KPLC's engineers or third party shall be carried out before shipment of the Equipment.
- 7.1.4. Technical support and software, where applicable upgrades shall be provided free of charge to KPLC for a period of not less than 36 months.
- 7.1.5. The Bidder shall submit a clause by clause statement of compliance with the specifications together with copies of relevant manufacturer's catalogues, brochures, technical data and proven test reports clearly marked to support each clause, all in English language for evaluation. The manufacturer's type reference/designation of the item offered shall also be indicated.
- 7.1.6. In the case of tender award, technical detailed design drawings for the 400V ACDP shall be submitted to the procuring entity for approval before manufacture commences.

7.2. Documentation

- 7.2.1. The bidder shall submit its tender complete with technical documents required by Annex A (Guaranteed Technical Particulars) for tender evaluation. The technical documents to be submitted (all in English language) for tender evaluation shall include the following:
- Guaranteed Technical Particulars signed by the manufacturer;
 - Copies of the Manufacturer's catalogues, brochures, detailed design drawings and technical data;
 - Sales records for the last five years and at least four customer reference letters;
 - Details of manufacturing capacity and the manufacturer's experience;
 - Copies of relevant type test reports by a third party testing laboratory accredited to ISO/IEC 17025;
 - Copy of accreditation certificate to ISO/IEC 17025 for the third party testing laboratory;
 - Manufacturers letter of authorization, ISO 9001:2008 certificate and other technical documents required in the tender.

Issued by: Head of Section, Standards Development	Authorized by: Head of Department, Standards
Signed: 	Signed: 
Date: 2015-10-27	Date: 2015-10-27



TITLE:
**SPECIFICATION FOR 420V
AC AUTOCHANGEOVER
DISTRIBUTION PANEL**

Doc. No.	KP1/6C.1/13/TSP/09/092
Issue No.	1
Revision No.	0
Date of Issue	2015-10-27
Page 17 of 23	

7.2.2. The successful bidder (supplier) shall submit the following documents/details to The Kenya Power & Lighting Company for approval before manufacture:

- a) Guaranteed Technical Particulars signed by the manufacturer;
- b) Design Drawings with details of the 400V ACDP to be manufactured for KPLC. The drawings shall include:
 - (i) Single line diagram for each type of 400V ACDP.
 - (ii) Dimensional drawing showing clearly the location of meter switches, MCBs, MCCB etc. in the 400V ACDP arrangement in plan and elevation with foundation details.
 - (iii) Wiring diagram of 400V ACDP showing the interconnection between terminals of various equipment and devices on and within the panel including approved schematic drawings.
 - (iv) Take off terminal connection arrangement.
 - (v) Catalogue of 400V ACDP equipment.
 - (vi) Ten (10) sets of approved drawings and ten (10) copies of Catalogue of 400V ACDP equipment shall be submitted to the Chief Engineer (Technical Services – Nairobi Region) for our record and distribution to site.
- c) Quality assurance plan (QAP) that will be used to ensure that the design, material; workmanship, tests, service capability, maintenance and documentation will fulfill the requirements stated in the contract documents, standards, specifications and regulations. The QAP shall be based on and include relevant parts to fulfill the requirements of ISO 9001:2008
- d) Detailed test program to be used during factory testing;
- e) All documentation necessary for safety of the equipment as specified in IEC 61010-1 clause 5.4 shall be provided with the equipment.
- f) Manufacturer's undertaking to ensure adequacy of the design, good engineering practice, adherence to the specification and applicable standards and regulations as well as ensuring good workmanship in the manufacture of the ACDP for The Kenya Power & Lighting Company;
- g) Packaging details (including packaging materials).

7.3 The supplier shall submit recommendations for use, care, storage and routine inspection/testing procedures, all in the English Language, during delivery of the 400V ACDP to KPLC stores

Issued by: Head of Section, Standards Development

Signed:

Date: 2015-10-27

Authorized by: Head of Department, Standards

Signed:

Date: 2015-10-27



TITLE:
**SPECIFICATION FOR 420V
 AC AUTOCHANGEOVER
 DISTRIBUTION PANEL**

Doc. No.	KP1/6C.1/13/TSP/09/092
Issue No.	1
Revision No.	0
Date of Issue	2015-10-27
Page 18 of 23	

ANNEX A: *Guaranteed Technical Particulars (to be filled and signed by the supplier and submitted together with copies of the Manufacturer's catalogues, brochures, drawings, technical data, sales records and copies of test certificates for tender evaluation)*

Tender No **Bidder's Name & Address**

	Description	Bidder's Offer
1	Name of the manufacturer and country of origin	Specify
	Type Reference Number or Model Number	Specify
2	Applicable Standards	Specify
3	Terms and Definitions	Specify
4	Requirements	
4.1	Service conditions	Specify
4.2	Design and Construction	
4.2.1.1	AC auto-changeover distribution panel rating	Specify
4.2.1.2	AC auto-changeover with a third off switch in absence of power from 2 normal sources	Specify
4.2.1.3	ATSE rating	Specify
	ATSE design	Specify
	Solid neutral poles on contactors with copper bar per breaker	Specify
	Mechanical and electrical interlocks availed	Specify
	Independent manual switch	Specify
4.2.1.4	AC Distribution compartment with 4 pole switch fuse disconnecter units	Specify
	With 16 outgoing feeders and MCBs	Specify
	With Visual and audible alarms for feeders tripping	Specify
4.2.1.5	Audio visual indication for AC supply	Specify
	Manual cancellation and reset of alarm for failure of AC supply	Specify
4.2.1.6	Acceptance and cancellation of the audible alarm shall be provided for	Specify
	The visual alarm shall only be cancelled upon supply restoration	Specify
4.2.1.7	Instrument compartment features	Specify
	Feeder compartment features	Specify
4.2.1.8	Cable entry at bottom of panel	Specify
	Entry holes of removable plates	Specify
	Cable termination accessories e.g. screwed brass cable gland and terminal blocks provided	Specify
	8no.x25mm ² holes on distribution side	Specify
	8no.x20mm ² holes on distribution side	Specify
	3no.x32mm ² holes on ATSE side	specify
4.2.1.9	Armored termination cables with armored rods connected to earth bus	Specify
	After isolation of power and control circuits, safe maintenance is possible	Specify

Issued by: Head of Section, Standards Development

Authorized by: Head of Department, Standards

Signed:

Signed:

Date: 2015-10-27

Date: 2015-10-27



TITLE:
**SPECIFICATION FOR 420V
 AC AUTOCHANGEOVER
 DISTRIBUTION PANEL**

Doc. No.	KPI/6C.1/13/TSP/09/092
Issue No.	1
Revision No.	0
Date of Issue	2015-10-27
Page 19 of 23	

	with adjacent circuit and bus bar live	
4.2.1.10	Connections from bus bars well insulated	Specify
	Partition between feeder compartment and cable alley material	Specify
	Partition allows cable cores with lugs to be easily inserted in feeder compartment	Specify
4.2.1.11	Safe earthing done	Specify
	All required earthing accessories provided	Specify
4.2.1.12	Galvanized steel earthing provided- welded/bolted to framework and breaker earthing contact bar	Specify
4.2.1.13	Earth bus cross section able to withstand short circuit and line fault currents to earth bus without exceeding allowable temperature rise	Specify
4.2.1.14	Earthing bus protrudes from panel and has predrilled holes for bonding to substation earthing	Specify
4.2.1.15	Panel shall be dust and vermin proof	Provide test report
4.2.1.16	Rust resistant primer paint applied	Specify
	Color of paint	Specify
4.2.1.18	Temperature rise of bus bars at rated current	Specify
4.2.1.19	Identical circuit breakers and module chassis shall be interchangeable	Specify
Table 1	Table 1: Requirements for 400V AC Auto-change-over Distribution Panel	
	Dimensions:	
	Height of complete panel (mm)	Specify
	Working height (mm), min	Specify
	Length(mm), min	Specify
	Width(mm), min	Specify
	Sheet steel thickness of panel(mm), min	Specify
	Panel board finish paint	Specify
	Ingress protection	Specify
	Clearances	Specify
	Creepage distances	Specify
	Insulation resistance of the equipment	Specify
	Resistance to corrosion	Specify
	Effective continuity between exposed conductive parts of the assembly and the protective circuits	Specify
	Grade of insulation level of equipment and wiring (KV)	Specify
	Power frequency withstand voltage, V_{peak}	Specify
	Power frequency withstand voltage, V_{rms}	Specify
	Annunciation for blowing of fuse or tripping of breaker	Specify
	Ammeter range	Specify
	Voltmeter range	Specify
	Accuracy class of Ammeter & Voltmeter	Specify

Issued by: Head of Section, Standards Development

Authorized by: Head of Department, Standards

Signed:

Signed:

Date: 2015-10-27

Date: 2015-10-27



TITLE:
**SPECIFICATION FOR 420V
 AC AUTOCHANGEOVER
 DISTRIBUTION PANEL**

Doc. No.	KP1/6C.1/13/TSP/09/092
Issue No.	1
Revision No.	0
Date of Issue	2015-10-27
Page 20 of 23	

	Current density of Copper for bus bar (A/sq.mm)	Specify	
	Wiring for annunciation scheme shall be done with copper of cross-section area (mm ²)	Specify	
	Internal wiring (Connection to MCBs) cable size/type & colour	Specify	
	Earth wiring size and colour code	Specify	
	Lifting lugs	Specify	
4.2.1.19.1	Relay characteristics	Standard of manufacture	Specify
		Type of relay or release	Specify
		Rated values	Specify
		Current setting / current setting range	Specify
		Time-current characteristics	Specify
		Influence of ambient air temperature	Specify
4.2.2.1	A set of tinned copper bus bars provided	Specify	
	Rating of copper bus bars/ short circuit rating	Specify	
4.2.2.2	Auxiliary relays with audio visual tripping indication/ electrical and mechanical interlocking/ tripping indication	Specify	
4.2.2.3	Bypass isolation switch	Operation	Specify
		Locks/interlocks operation	Specify
		Operation of bypass handle to allow for direct connection of load to the normal(or emergency) source	Specify
Table 2	Utilization category	Specify for Auto transfer switch and bypass switch	
	Class of equipment		
	Rated duty		
	Rated voltage		
	Maximum power frequency or dc recovery voltage		
	Dielectric strength at 50z in 1 min		
	Rated impulse withstand voltage		
	Rated thermal current		
	Rated operational power		
	Rated operational current, I _o		
	Rated breaking and making capacity, I		
	Rated short time withstand current, I _{ow} for 1s		
	Rated short time making capacity, I _{cm}		
	Rated conditional short-circuit current, I _p		
	Power loss per pole		
Operating cycle			
Number of operating cycles corresponding to the rated operational current			
Number of mechanical operations			
4.2.2.5	ON, OFF, TRIP indicating lamps provided	Specify	
4.2.2.6	Digital voltmeter	Scale range	Specify
		Flush mounted	Specify

Issued by: Head of Section, Standards Development	Authorized by: Head of Department, Standards
Signed: 	Signed: 
Date: 2015-10-27	Date: 2015-10-27



TITLE:
**SPECIFICATION FOR 420V
 AC AUTOCHANGEOVER
 DISTRIBUTION PANEL**

Doc. No.	KP1/6C.1/13/TSP/09/092
Issue No.	1
Revision No.	0
Date of Issue	2015-10-27
Page 21 of 23	

		Dimensions	
		Accuracy	Specify
		Overvoltage category	Specify
4.2.2.7	Digital Ammeter	Scale range	Specify
		Flush mounted	Specify
		Dimensions	Specify
		Accuracy	Specify
		Overvoltage category	Specify
4.2.2.8	Panel lamp at back of door with door switch		Specify
	Separate switch fuse unit		Specify
4.2.2.9	Indicating lamps	Panel mounting cluster LED type	Specify
		With size plate marked with its function	Specify
		With Translucent lamp covers RED, GREEN, WHITE	Specify
4.2.2.10	Space heaters	Suitable for continuous operation at 240V 50Hz	Specify
		With thermostats	Specify
		Isolating switches provided	Specify
4.2.2.11	All MCBs, Auxiliary relays, Isolating copper links, Emergency MCBs & contactors, bells, indicating lamps provided		Specify
	Push buttons for testing, resetting and cancellation provided		Specify
4.2.2.12	One Terminal board /block	with facility to select phase-phase voltage levels	Specify
		Shall pick contacts indicating loss of incoming supply	Specify
4.2.2.13	A.C Circuit breakers time constant		Specify
	Rated short circuit capacities		Specify
	Instantaneous tripping characteristics		Specify
	Rated impulse withstand voltage (U_{peak})		Specify
	Two pole circuit breakers with two protected poles		Specify
Table 3	Type of breaker		Specify
	Method of mounting		Specify
	Utilization category		Specify
	Current rating		Specify
	Rated voltage		Specify
	No. of poles		Specify
	Type of terminals		Specify
	Insulating voltage		Specify
	Rated impulse withstand voltage of main circuit U_{imp}		Specify
	Temperature rise		Specify
	Instantaneous tripping current		Specify
	I^2t characteristics		Specify
	Rated continuous current at 40°C		Specify
	Short-time withstand capacity, I_{cw} for 0.1s		Specify

Issued by: Head of Section, Standards Development

Authorized by: Head of Department, Standards

Signed:

Signed:

Date: 2015-10-27

Date: 2015-10-27



TITLE:
**SPECIFICATION FOR 420V
 AC AUTOCHANGEOVER
 DISTRIBUTION PANEL**

Doc. No.	KP1/6C.I/13/TSP/09/092
Issue No.	1
Revision No.	0
Date of Issue	2015-10-27
Page 22 of 23	

	Ultimate short circuit breaking capacity I_{cu}	Specify
	Service short circuit breaking capacity I_{cs}	Specify
	Ultimate short circuit making capacity I_{cu}	Specify
	Maximum power loss	Specify
	Suitable for isolation	Specify
	Shunt release voltage	Specify
	Permissible variation in voltage	Specify
	Number of operating cycles	Specify
	Termination suitable for copper	Specify
	Insulation material conforming to glow wire test	Specify
	Thermal over load settings	Specify
	Short circuit setting	Specify
	Degree of protection	Specify
4.2.3	Wiring and labeling done at factory	
	Current carrying wires (black) with ferrule labels	Specify
	Earthing wire yellow/green	Specify
	Control cables grey with ferrule marking	Specify
	Voltage carrying wires coded Red, Yellow, Blue and Black	Specify
4.3	Quality Management System	Provide
	Quality Assurance Plan	Provide
	Copy of ISO 9001:2008 certificate	Provide
	Manufacturer's experience	Provide
	Manufacturing capacity (Units per month)	Provide
	List of previous customers	Provide
	Customer reference letters	Provide
5.1	Test standards and responsibility of carrying out tests	Provide
5.2	Copies of Type Test Reports submitted with tender	Provide
5.3	Acceptance tests to be witnessed by KPLC at factory before shipment	Provide
5.4	Test reports to be submitted by supplier to KPLC for approval before shipment	Provide
5.5	Replacement of rejected panels	Provide
6.1	Packing	Provide
6.2	Marking	Provide
7.1	Warranty and training	Provide
7.2	Documents submitted with tender	Provide
	Documents to be submitted by supplier to KPLC for approval before manufacture	Provide
8.0	Statement of compliance to specification	Provide

Issued by: Head of Section, Standards Development

Authorized by: Head of Department, Standards

Signed:

Signed:

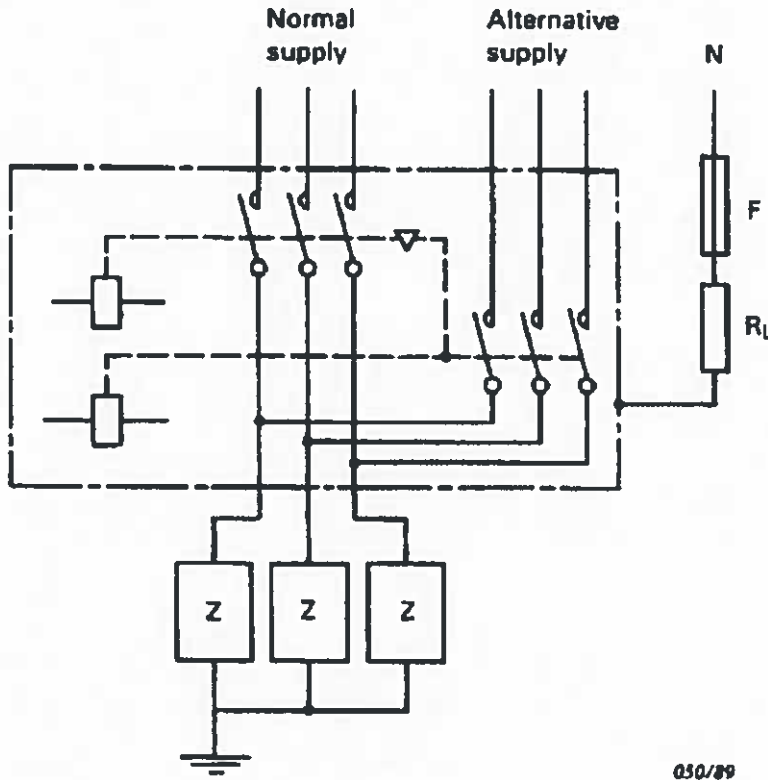

Date: 2015-10-27

Date: 2015-10-27



050/89

Fig. 1: Connection circuit of ATSE showing the electrical conditions without the mechanical conditions.

Issued by: Head of Section, Standards Development	Authorized by: Head of Department, Standards
Signed: 	Signed: 
Date: 2015-10-27	Date: 2015-10-27

